

PN32-551-24U

INCLUDED ACCESSORIES

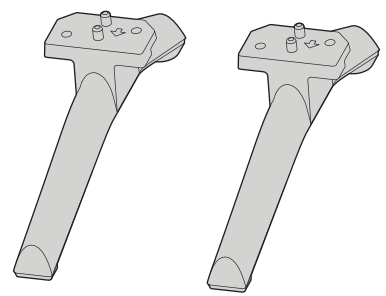

Voice Remote and two AAA batteries



Stands

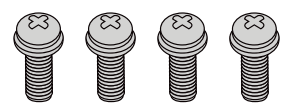

Q4 screws (16 mm length) (4 pcs.)
Screws

IMPORTANT: See the installation instructions and online *User Guide* before connecting the power cord.

FIND YOUR USER GUIDE ONLINE!

Go to www.usca.pioneer-tv.com and search for PN32-551-24U.

WHAT YOU NEED (not included)

- Phillips screwdriver
- Internet connection (wireless) *

*Subscription or other payment may be required to access certain content.

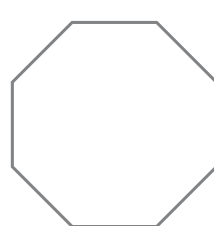

STOP

Before using your new product, read these instructions to prevent any damage. Do not plug your power cord in until all other devices have been connected.

1 START HERE

How do I attach the stands to my TV? (not for wall mounting)

Carefully place your TV face-down on a cushioned, clean surface. Use a Phillips screwdriver to secure each TV stand to the bottom of your TV with two of the provided screws.

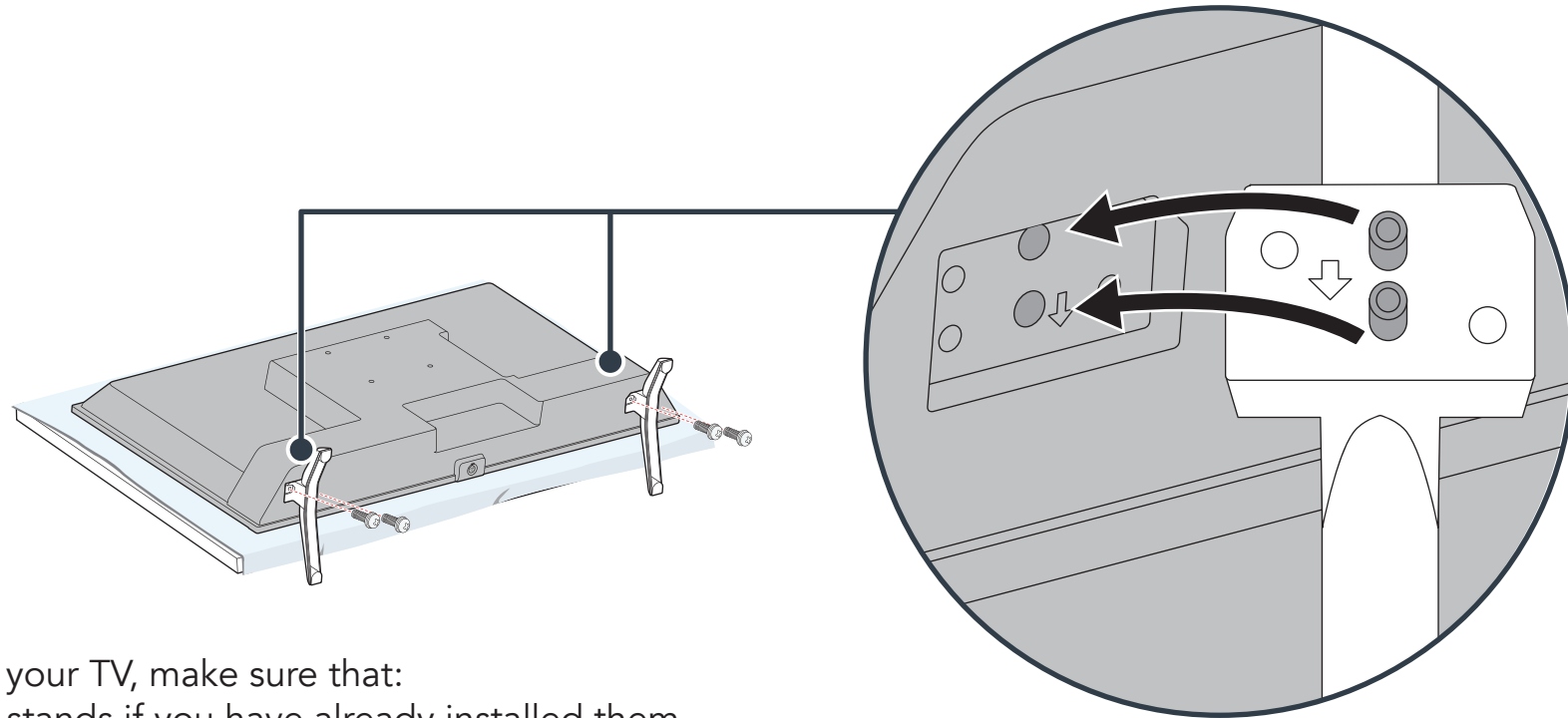

Before you mount your TV, make sure that:

- You remove the stands if you have already installed them.
- The wall-mount bracket supports the weight of your TV.

See the instructions that came with your wall mount for more information about how to correctly mount your TV.

WARNING: Your TV has four VESA mounting holes on the back. **You must secure a wall-mount bracket to all four holes.** If you do not use all four holes, your TV may fall and cause property damage or personal injury. **Note:** Wall-mount screws are not included.

VESA mounting holes

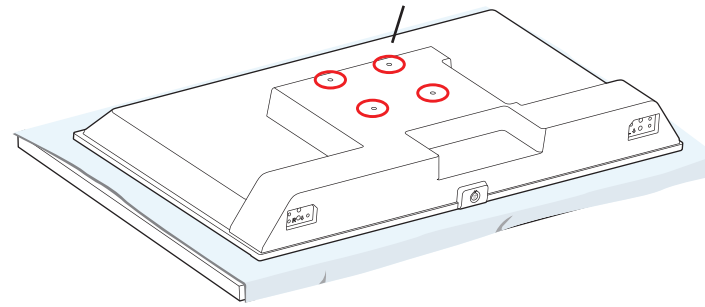

VESA Mounting Pattern
100 × 100 mm
M4 × 6 to 8 mm screws
(4 pcs.)

FEATURES

Front

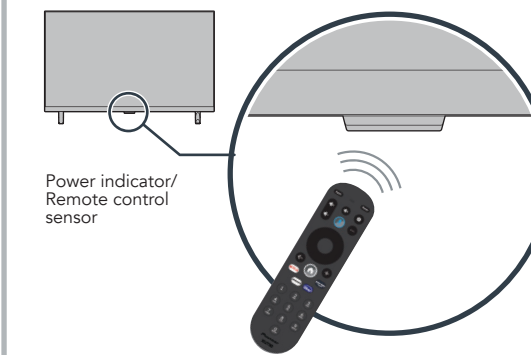

Power indicator/Remote control sensor

Bottom

INPUT button
Press to turn on your TV. When your TV is on, press to cycle through the power and input selections.

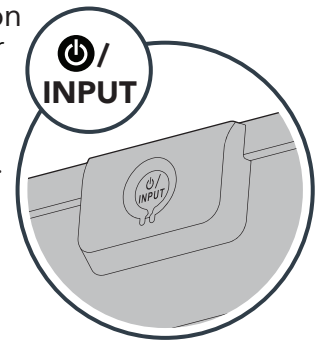

Back

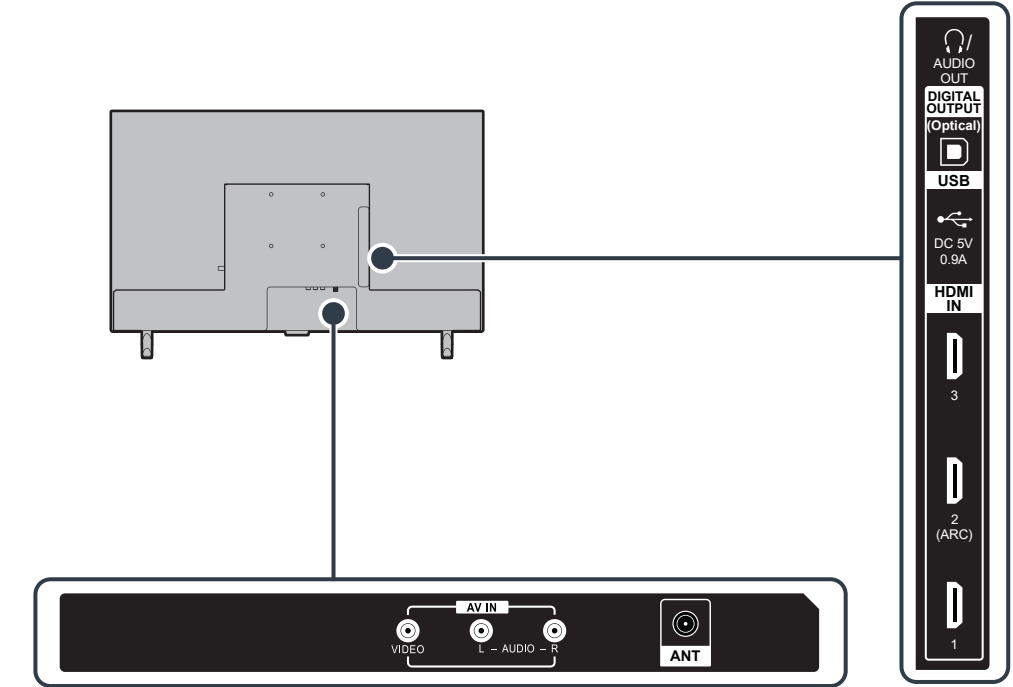

Note: Images do not necessarily represent the exact design of your television.

2 MAKING CONNECTIONS

How do I watch TV (cable, satellite, or antenna) or connect a device such as a DVD or Blu-ray disc player or game console? How do I connect to the internet?

VIDEO OPTIONS

HDMI (BEST)

Best video quality

Note: Connect an ARC-enabled home theater receiver to the **HDMI IN 2 (ARC)** jack.

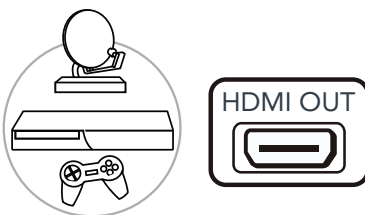

HDMI options

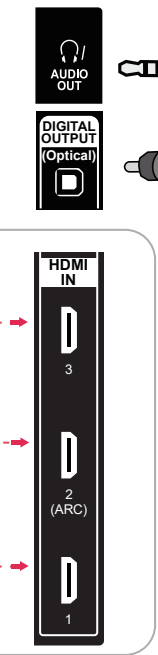

AUDIO OPTIONS
USING ANALOG AUDIO

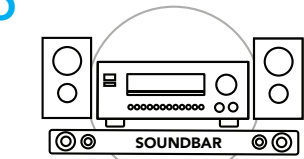
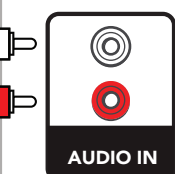

You can use the **DIGITAL OUTPUT (Optical)** jack or the **HDMI IN 2 (ARC)** jack.

USING DIGITAL AUDIO

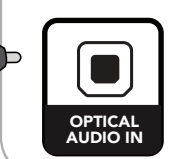

Note: If you need to change the digital audio format, press the settings button, then select **Picture & Sound**. Select **Audio Settings**, then select **Digital Audio Output** and change the setting to **PCM** or your preferred audio format.

VIDEO OPTIONS

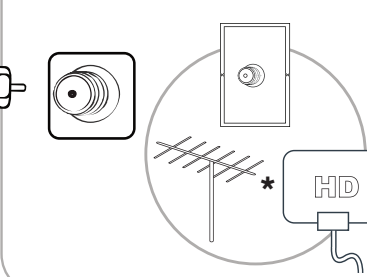

COAXIAL (GOOD)

Note: Connect a cable box, a cable wall jack, or an HD antenna.

AV (GOOD)

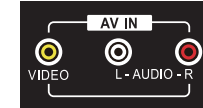
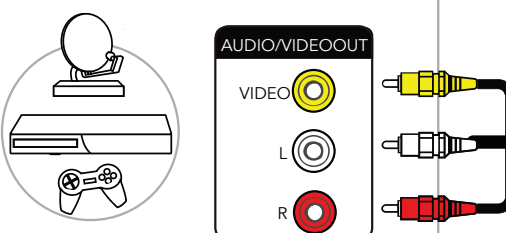

3 TURNING ON MY TV

When can I turn on my TV?

WHEN YOUR TV IS IN PLACE:

1 Plug in your TV.

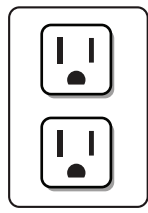

2 Remove the remote control cover and install the batteries.

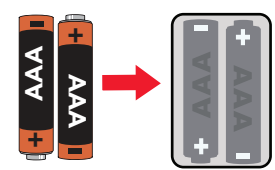

3 Press **Power** on your Voice Remote.

4 Follow the on-screen instructions.

4 COMPLETE WI-FI SETUP

How do I complete Wi-Fi setup?

Your TV will guide you through the rest of the setup process with on-screen prompts. When you're done, you'll be directed to the home screen.

If you'd like to connect your TV to the Internet (recommended):

- 1 Connect your TV to your Wi-Fi network using your Wi-Fi network name (SSID) and password.
- 2 When the activation code is displayed on the TV screen, go to the website link indicated using a mobile device, a computer, or a tablet, and create your Xumo TV account with a payment method if you would like to make purchases on your TV.

Note: Xumo TV account is optional.

After you've set up your TV, you will be automatically directed to the home screen.

5 CREATING XUMO TV ACCOUNT

Do I need a Xumo TV account?

You don't need an account to use your Xumo TV, but without it you won't be able to make purchases through your TV, and you may miss out on special offers like free trials.

You can also use your Xumo TV account to manage your preferences, subscriptions, and paired devices.

How do I create my Xumo TV account?

You'll be prompted to create a Xumo TV account when you set up your TV. All you need is an email and password. You'll also need to add a credit or debit card as your payment method to make purchases on your TV.

Can I use the same Xumo TV account for multiple TVs?

Yes! You can link multiple TVs to the same Xumo TV account. Just sign in with your Xumo account.

Pioneer

xumoTV

The Joy of Streaming™ with Xumo TV

ENDLESS STREAMING

Enjoy watching all the top apps like Netflix, YouTube, Disney+, Amazon Prime Video, Peacock and more. And with Xumo Play, you'll have quick access to 300+ free channels, available to stream immediately.

MY LIST

No more scrolling through endless lists or trying to remember that one movie you've been meaning to watch. My List keeps everything together, so you spend less time searching within apps.

SUPER SIMPLE TO USE

Intuitive navigation. Set up and watch in minutes. Included voice remote lets you use your voice to search.

Access the online User Guide

Go to www.usca.pioneer-tv.com and search for your model number. Many questions regarding parts, service, and warranties can be answered by visiting the Support section of our website: www.usca.pioneer-tv.com

Contact Pioneer TV Customer Support Center:

1-888-287-7658 (U.S. or Canada)

Contact Xumo TV Customer Support:

<https://tv.xumo.com/support>

HDMI
HIGH-DEFINITION MULTIMEDIA INTERFACE

Dolby
AUDIO

The terms HDMI, HDMI High-Definition Multimedia Interface, HDMI Trade dress, and the HDMI Logos are trademarks or registered trademarks of HDMI Licensing Administrator, Inc.

Dolby, Dolby Audio, and the double-D symbol are trademarks of Dolby Laboratories Licensing Corporation. Manufactured under license from Dolby Laboratories. Confidential unpublished works. Copyright © 1992-2019 Dolby Laboratories. All rights reserved.

PIONEER and the Pioneer logo are registered trademarks of Pioneer Corporation, and are used under license.

Not all apps and content available in 2K (HD).

Available programming and apps subject to change at any time; see tv.xumo.com for currently available apps. Not all programming and apps available in all areas. Separate subscriptions required to access various apps, including Netflix, Apple TV+, YouTube, Prime Video, Disney+, Hulu, Peacock, Max, and Spotify. HD availability subject to internet service, network conditions, device capabilities and content availability. The availability and performance of applications and content in this TV vary from country to country and your subscription plan and are subject to change over time. Please verify availability in your intended use location prior to purchasing. Xumo TV, Xumo Play, the Xumo logos, and all other Xumo product names, logos, slogans, or marks are the trademarks of Xumo or its licensors. All other product names, trademarks, logos, and brands are the property of their respective owners. ©2023 Xumo. All Rights Reserved.

Distributed and warranted by Best Buy Purchasing LLC
7601 Penn Avenue South, Richfield, MN 55423 USA
©2024 Best Buy. All rights reserved.

To reduce the risk of fire or electric shock, do not remove any cover or expose the device to rain or moisture. No user-serviceable parts are inside. Refer servicing to qualified service technicians.

USING YOUR VOICE REMOTE

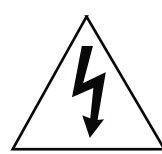
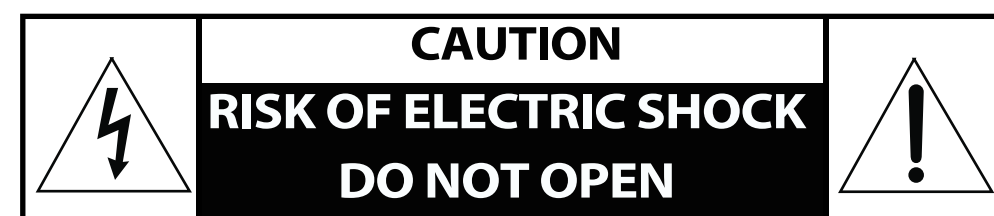

This symbol indicates that dangerous voltage constituting a risk of electric shock is present within your TV. This label is located on the back of your TV.



This symbol indicates that there are important operating and maintenance instructions in the literature accompanying your TV.

SERVICING

Servicing instructions are for use by qualified service personnel only. To reduce the risk of electric shock, do not perform any servicing other than that contained in the operating instructions unless you are qualified to do so.

